

Instruction Manual for: Kirk Hybrid (MD) and 316 (HD) Series Interlocks

Work **SAFE** For **LIFE**™



Kirk Key Interlock Company

9048 Meridian Circle NW, North Canton, OH 44720

Phone: 234.209.9301 • Fax: 330.497.4400

Toll Free: 1.800.438.2442

www.kirkkey.com

Table of Contents:

Type F and Type B Interlock.....	Page 2
Type DM, D Access Door Interlock.....	Page 3-4
Transfer Panel and Transfer Block.....	Page 5-6
Type TPS Switch.....	Page 6
Dust Cover.....	Page 7
Key Control and Duplicate Keys.....	Page 7-8
Service and Maintenance.....	Page 8
Duplicate Key Release Form.....	Page 9-10

Table of Contents:

Installation Instructions

See specific KIRK product data sheets for additional information and installation instructions at kirkkey.com

Proper installation of key interlocks is a critical element of a key interlock system. It is essential that each interlock be installed so that the lock bolt cannot be extended unless the equipment on which it is installed is in the proper position/condition. After installation of the interlocks, the complete system should be tested sequentially by person(s) familiar with the entire system, key routing, and its intended purpose. Any problems or discrepancies must be corrected prior to energizing the equipment.

KIRK Hybrid and 316 Series interlocks with multiple cylinders require insertion of all withdrawn keys in sequence before the lock bolt can be extended or withdrawn. Likewise, transfer blocks and transfer panels (which do not have exposed lock bolts) require sequential insertion of all withdrawn keys before allowing release of held keys. Insert and turn missing keys (starting from the end) and work your way towards the held keys. Detailed operating instructions are provided inside this manual.

Once the complete interlock system is installed, all installation keys must be removed from the system and destroyed or secured and controlled by a responsible person. There should be only enough keys to operate the interlock system sequentially. Kirk Key Interlock Company will not be responsible for extra keys left in the interlock system.

Instruction Manual for: Kirk Hybrid (MD) and 316 (HD) Series Interlocks

KIRK Hybrid and 316 Series Interlocks (Type F, Type B)

The key interlock should be mounted so that the 5/8" diameter lock bolt can be extended to lock the device at the proper position. In the unlocked position, the lock bolt should be blocked from extending, thereby trapping the key(s) in the interlock.

Type F and Type B Terminology and Operating Instructions

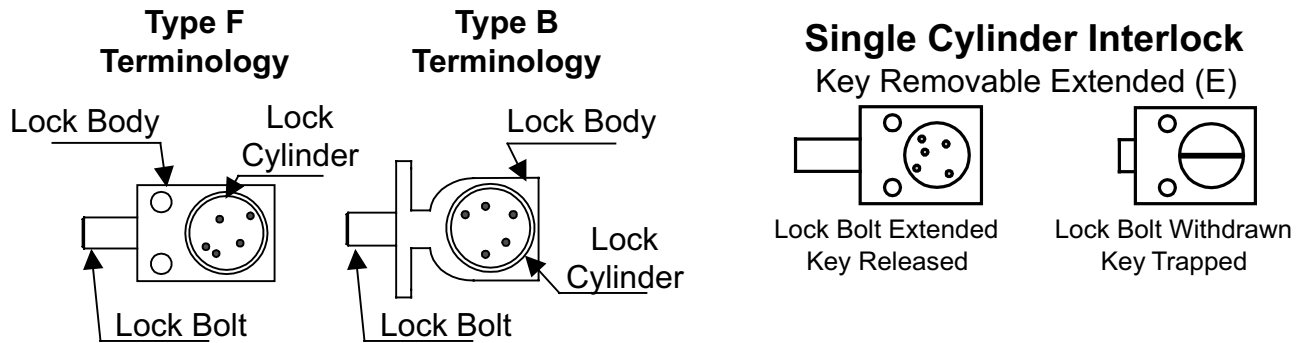

Multiple cylinder interlocks can be designed to release more than one key when the lock bolt is extended, or designed to provide a key exchange while extending or retracting the lock bolt. See the drawings below.

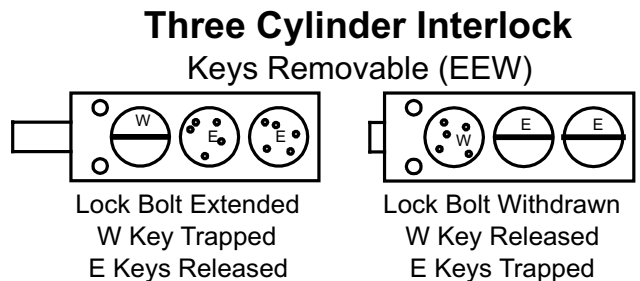
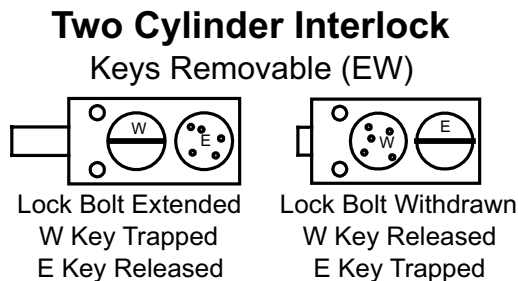
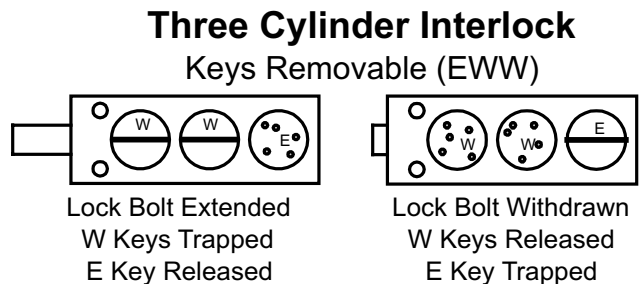
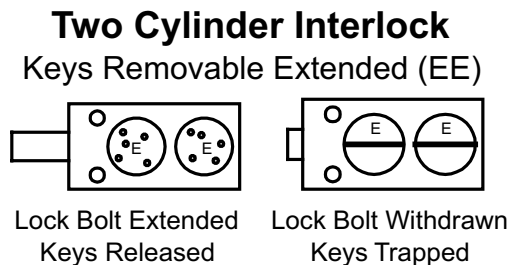

All missing keys must be inserted and turned before any trapped keys can be released. Insert and turn the missing keys, one at a time (starting from the end) and work your way towards the trapped keys. When extending the lock bolt of a multi-cylinder interlock, turn the key nearest the lock bolt first - when withdrawing the lock bolt of a multi-cylinder interlock, turn the key farthest from the lock bolt first. The interlock installer should be familiar with the entire system, the key routing, and the intended purpose of the complete interlock system.

Instruction Manual for: Kirk Hybrid (MD) and 316 (HD) Series Interlocks

KIRK Hybrid and 316 Series Door/Access Interlocks (Type DM, Type D)

All Type DM interlocks have two parts: a main body with one or two cylinders and a latch bolt with chain. When the latch bolt is separated from the main body, the key is trapped in the lock. When the door on which the interlock is mounted is properly closed, the latch bolt can be inserted into the main body and the key can be turned and released.

Weld or bolt the chain to the door or door-frame allowing enough slack to insert and turn the latch bolt in the Type DM lock body when the door is properly closed. When using optional DM4 mounting plate illus. (A) below, the plate can be welded to a door or door frame, illus. (B) below. The Type DM interlock will bolt to the mounting plate using 3/8-16 x 2 1/4" bolts, 3/8-16 nuts, and 3/8" split lock washers.

DM Terminology and Operating Instructions

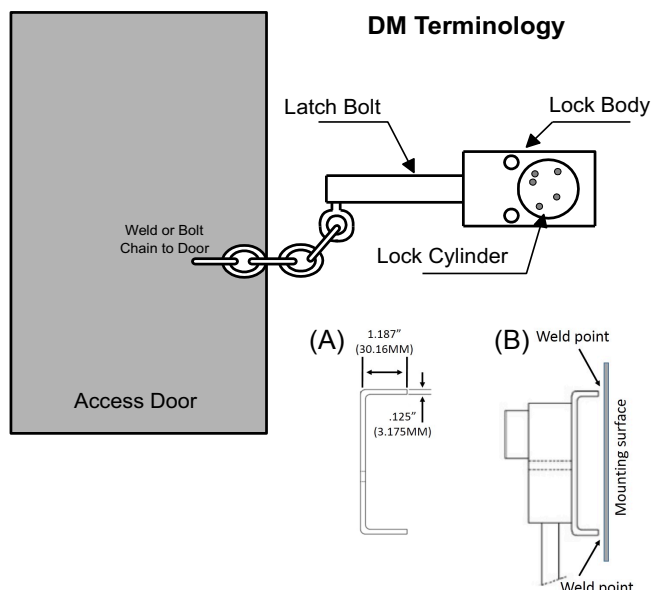

Single Cylinder DM Instructions

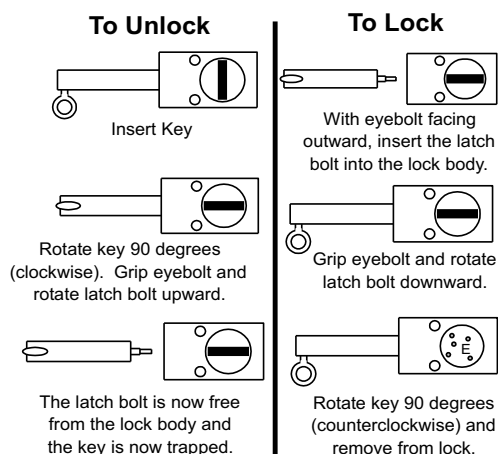

Two Cylinder DM (EE) Instructions

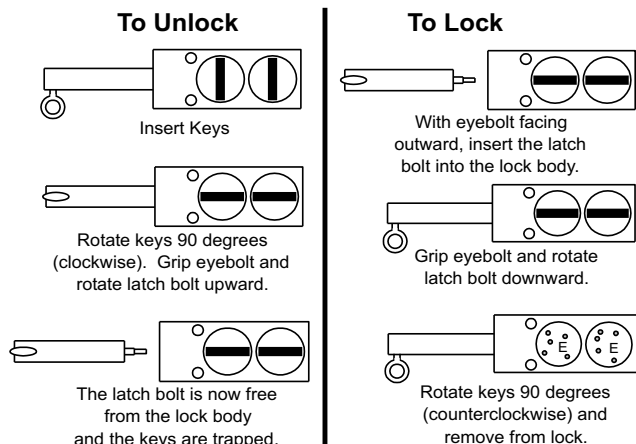

Two Cylinder DM (with Personnel Key) (EW) Instructions

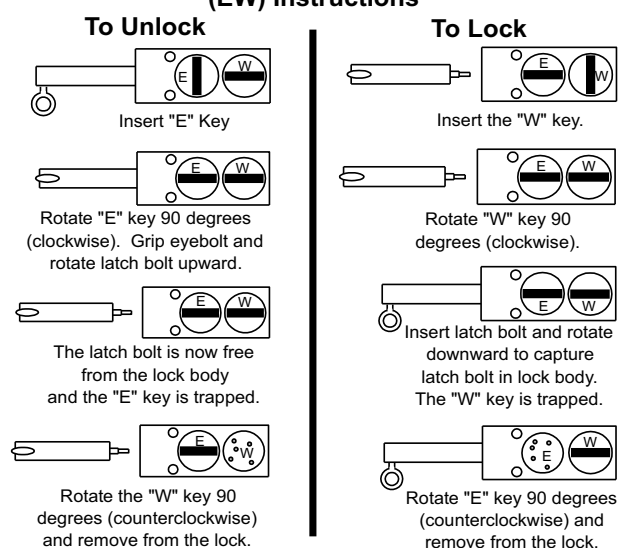

The "E" keys can be turned and released when the latch bolt is latched and the "W" keys can be turned and released when the latch bolt is unlatched.

Instruction Manual for: Kirk Hybrid (MD) and 316 (HD) Series Interlocks

Type D Door Interlock

All Type D interlocks have two parts: a main body with one or more cylinders and a latch block. Proper alignment of both parts is crucial to the operation of a Type D interlock. When the main body is separated from the latch block, the lock bolt is retained in the withdrawn position by concealed latch pins. Thus the key(s) is always held in the lock whenever the two parts are separated. When the door on which the interlock is mounted is properly closed, the key(s) can be turned to extend the lock bolt into the latch block, securing the door. Only extending the lock bolt, after properly closing the door, should allow release of the key(s). An exception to this rule is a multiple cylinder Type D interlock which allows release of a "personnel" key when the door is opened. The personnel key can be put in the pocket of the maintenance person ensuring that the door cannot be closed and locked as long as he holds the personnel key.

Type D Terminology

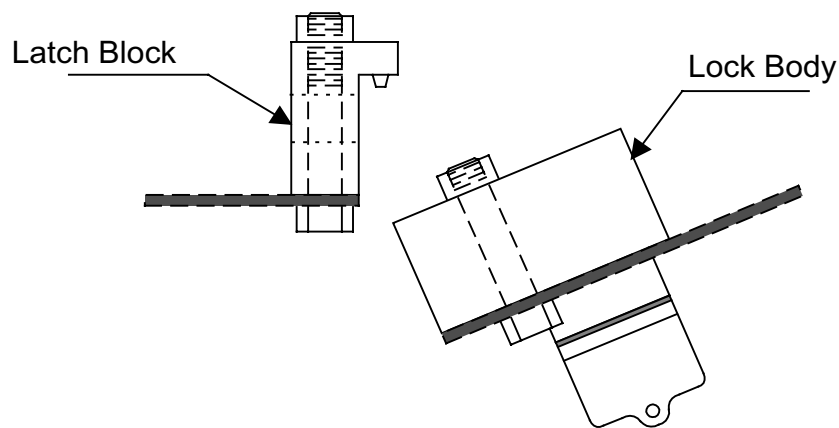

The key is trapped in type D interlock when the door is open.

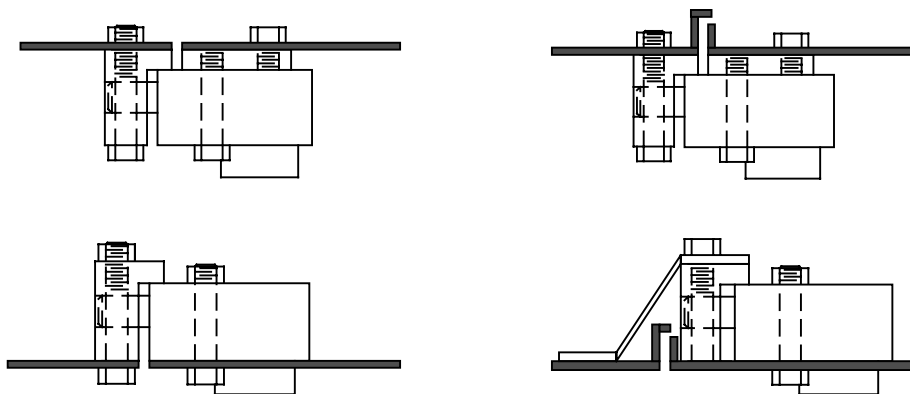

Mounting Options for Type D Locks and Latch Blocks

KIRK door interlocks should not be used to align the door, or be the latching means for holding the door in the closed position. Type DM interlocks should be utilized in situations where the door and door-frame are ill-fitting, and a degree of latitude is required.

Instruction Manual for: Kirk Hybrid (MD) and 316 (HD) Series Interlocks

KIRK Hybrid and 316 Series Transfer Panels and Transfer Blocks

A transfer panel or transfer block is a group of primary and secondary locks involved in a transfer step (also known as a key exchange). All primary keys must be inserted and turned before any secondary keys can be released. Transfer panel primary keys are generally related to power sources (such as breakers, T/R switches, level detectors, etc.) and secondary keys are often associated with access doors.

"Hybrid and 316 SERIES" KEY TRANSFER PANEL OPERATING INSTRUCTIONS

TYPICAL PANEL SHOWN. THE NUMBER OF KEYS IN THE
SEQUENCE WILL VARY DEPENDING ON THE PANEL SIZE.

SECONDARY KEYS TRAPPED

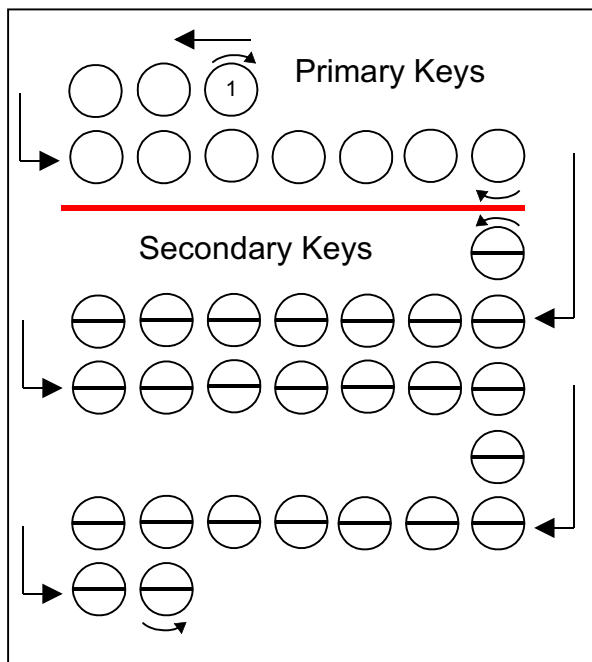

① = Initiating Key

To Release Secondary Keys:

All keys must be inserted in the proper order starting with the first key in the top row. Insert and turn each key (one at a time) in order to trap that key and move on to the next key in the sequence (follow the arrows). Once all keys above the line have been inserted and turned, the keys below the line will be available for removal in a continuation of the same sequence (one at a time).

PRIMARY KEYS TRAPPED

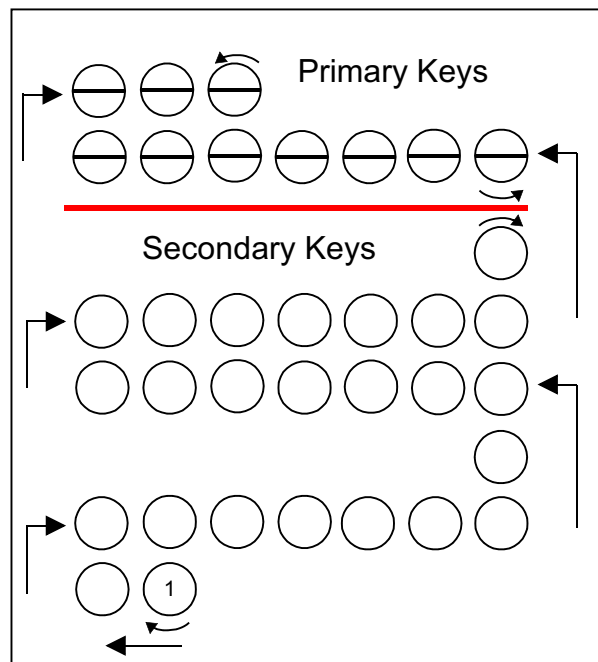

① = Initiating Key

To Release Primary Keys:

Insert all keys below the line starting with the last key on the bottom row. Insert and turn each key (one at a time) in order to trap that key and move on to the next key in the sequence. Once all keys below the line have been inserted and turned, the keys above the line will be available for removal in a continuation of the same sequence (one at a time).

Instruction Manual for: Kirk Hybrid (MD) and 316 (HD) Series Interlocks

Hybrid and 316 Series Type T Transfer Blocks

Two Cylinder Transfer Block

Keys Removable (EW)

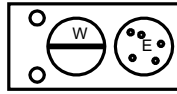

W Key Trapped
E Key Released

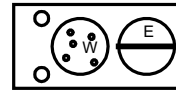

W Key Released
E Key Trapped

Three Cylinder Transfer Block

Keys Removable (EWW)

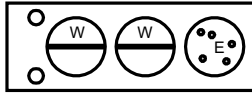

W Keys Trapped
E Key Released

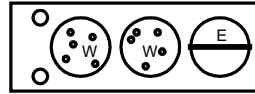

W Keys Released
E Key Trapped

Three Cylinder Transfer Block

Keys Removable (EEW)

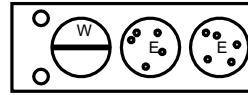

W Key Trapped
E Keys Released

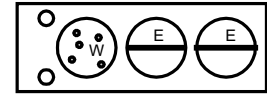

W Key Released
E Keys Trapped

Hybrid and 316 transfer panels and transfer blocks are designed to accept and release keys sequentially. Insert and turn the missing keys (one at a time starting from the end) and work your way towards the held keys. The held keys will be released (one at a time) in a continuation of the same sequence. Reverse the key sequence when going back through the interlock system.

KIRK Hybrid and 316 Series Type TPS (and TPSS) Interlock Switches

The Hybrid and 316 Series Type TPS interlock is a key actuated switch designed for back-panel mounting. The TPS has two normally open and two normally closed contacts. The TPSS has four normally open and four normally closed contacts. The contact blocks are clearly marked with the status of the contacts. After wiring, the installer must test the wiring to verify that the circuitry corresponds to the desired key position (trapped vs. free).

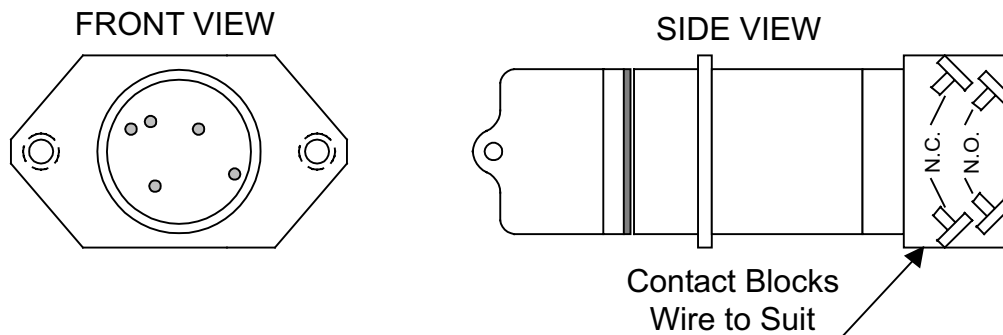

Instruction Manual for: Kirk Hybrid (MD) and 316 (HD) Series Interlocks

Dust Cover (Available Option)

The Flip Open dust cover is designed to provide protection to the lock cylinder when the gasketed key is removed from the interlock. The cover is hinged and held closed with spring tension. A single set screw attaches the dust cover to the lock cylinder.

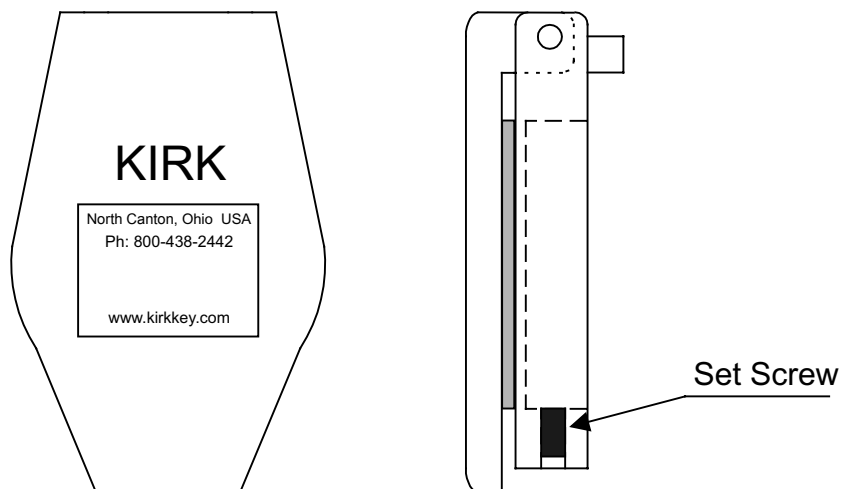

Key Control

To ensure correct operation of the KIRK interlock system it is necessary to remove all loosely held or installation keys before operation of the equipment on which the interlocks are mounted. There should be only enough keys to operate the interlock system sequentially.

The keys removed from the KIRK interlocks should be returned to Kirk Key Interlock Company, North Canton, Ohio, or secured and controlled by authorized personnel for use as spare keys.

The spare keys must not be normally available to operating personnel, since the use of these keys, where not specifically required, will result in incorrect operation of the equipment on which the interlocks are mounted. Any spare keys should be given to operating personnel only if, and when, the corresponding operating key has been destroyed.

ADDITIONAL KEYS will be provided ONLY with proper authorization from the ultimate user to which the specific key combination has been assigned.

Duplicate Keys

Sometimes extra (installation) keys are required during the installation phase of a project. This provides more keys than are actually necessary for operation of the interlock system. When the interlocks have been installed, all extra keys should be removed from the system

Instruction Manual for: Kirk Hybrid (MD) and 316 (HD) Series Interlocks

and destroyed or secured and controlled by authorized personnel. If additional keys are required because of loss or damage, they can be supplied only on the purchaser's authorized order. To order additional or replacement keys, please:

- 1) Copy the duplicate key release form on page 9 & 10 of this manual, or print from <http://www.kirkkey.com>.
- 2) Complete the form and sign your name.
- 3) Fax the form to Kirk Key Interlock Company for immediate delivery, at 330-497-4400.

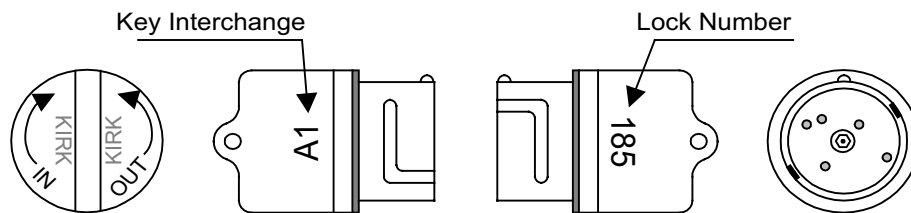

Hybrid and 316 Series Stainless Steel Key

Service and Maintenance

Lubrication - interlocks should be periodically lubricated with a small amount of dry powdered graphite. Do not use oil of any type as the oil will collect dirt and "foul" the interlock so that it will not operate. Squirt a small amount of graphite behind the inner turn shaft and the base of the lock bolt where it protrudes from the lock body. Turn the key several times in order to distribute the graphite. Kirk Key Interlock Company cannot warranty interlocks that have been oiled.

Kirk Key Interlock Company offers a graphite lubrication kit (part number GL-1) complete with instructions for use. The powdered graphite is supplied in a plastic tube that can be "squeezed" to force a small amount of graphite into the interlock. As described above, turn the key a few times to distribute the graphite.

NOTE: A dust cover should be utilized to protect the lock cylinders when located outdoors or in a demanding environment. Dust covers are available separately and can be easily added to any interlock.

Factory Service Under normal operating conditions, KIRK interlocks should not require any maintenance service, other than graphite lubrication. However, if refurbishment or replacement should be required, contact Kirk Key Interlock Company, North Canton, Ohio. All factory service will be performed as quickly as possible to minimize your down time.

Any damaged or malfunctioning interlocks should be returned to Kirk Key Interlock Company, North Canton, Ohio. If this is not possible and replacement interlocks are required, the following information must be forwarded to Kirk Key:

- 1) Lock Number - obtain from the face of the lock cylinder and thumb-side of the key.
- 2) S.O. Number - obtain from the nameplate on the interlock.
- 3) Item Number - obtain from the nameplate on the interlock.
- 4) Key Interchange Number (if applicable) - obtain from the finger-side of the key.