

Type FF Isolation Interlock

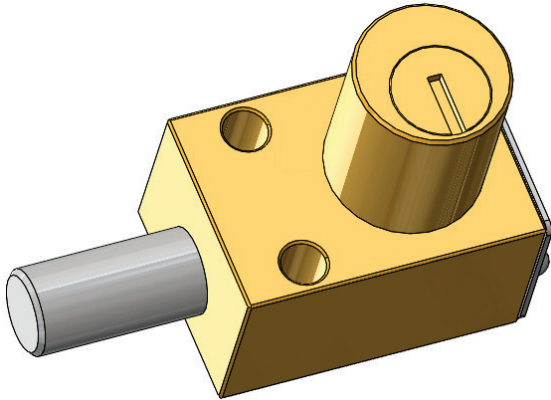

Part of the
Sentric Group



KIRK Type FF is the smallest of the KIRK bolt interlocks. It is a key operated mechanical interlock that is suitable for the control of electrical switchgear. The standard unit comes with a stainless steel 1/2" diameter locking bolt with a throw or travel of 3/4". The locking bolt is used to control the rotation or movement of operating handles or toggles of electrical switchgear. Many suppliers of switchgear equipment have mounting provisions available for KIRK interlocks.

OPERATION

KIRK Type FF interlocks are mechanically operated and suitable for the control of electrical switchgear and to inhibit movement of cams, toggles, or levers.

Type FF key operated mechanical isolation interlock

1 Key is trapped, bolt is withdrawn.

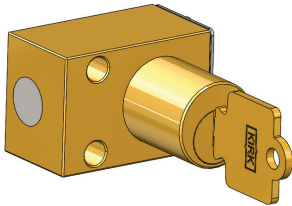

2 Change state of power, turn key, which extends bolt, releasing key.

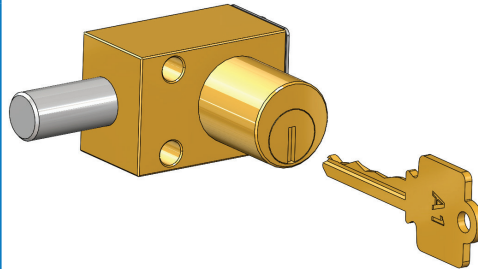

3 Bolt is now a physical barrier to switch and key is free to move to the next sequential interlock in the safety process.

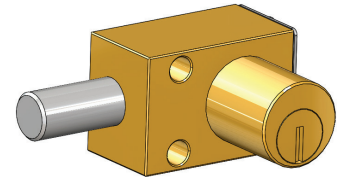

The length of the bolt is available in various lengths to suit each unique application. The travel of the bolt is always 3/4".

Type FF Isolation Interlock



Part of the
Sentric Group

USAGE

The KIRK Type FF is designed for smaller spaces and is the smallest of the KIRK bolt interlocks.

KIRK bolt interlocks should be used on equipment as a physical barrier to electrical switches, push buttons, or levers. KIRK bolt interlocks ensure that once the equipment is switched into the desired position as defined by the end user's safety process and following the operations of the interlock, the switch is now blocked from changing state until the procedure is reversed.

 KIRK isolation interlocks are not designed to serve as an access interlock into hazardous areas.

No hazardous substances were used in the manufacturing of the product. The product can be disposed of in standard waste receptacles.

INSTALLATION

The KIRK Type FF is face mounted through the front of the housing. Proper installation of bolt interlocks is a critical element of a key interlock system. It is essential that each interlock be mounted so that the 1/2" lock bolt cannot be extended unless the equipment on which it is mounted is in the proper position/condition. After installation of the bolt interlocks, the complete interlock system should be tested sequentially by person(s) familiar with the entire system, the key sequence, and its intended purpose. Any problems or discrepancies must be corrected prior to energization.

SD series (brass) interlocks are supplied with a key in each cylinder. These keys are needed during installation of the interlocks. SD series (brass) bolt interlocks with multiple cylinders require the insertion of all keys before the lock bolt can be extended or withdrawn. Do not try to force a multiple cylinder interlock that does not have the correct keys fully inserted in every cylinder!

 For all interlock systems to maintain system integrity, additional keys must be removed from the system and destroyed or retained by a responsible person. There should only be enough keys to operate the interlock system sequentially. Kirk Key Interlock Company will not be responsible for extra keys left in the interlock system.

 All interlocks and interlock systems must be installed by a competent and qualified person who has read and understood these instructions. Please retain this document in your technical files.

MAINTENANCE

Kirk key interlocks should be periodically lubricated with a small amount of dry powder graphite. DO NOT use oil or grease of any type as these will collect dirt and impede the proper operation of the lock cylinder.

SD SERIES: Apply a small amount of graphite to the key and insert the key into the lock cylinder. Work the key in an out and turn the key several times in order to distribute the graphite inside the lock cylinder.

KIRK offers a Graphite Lubrication kit (part# GL-1) complete with instructions for use.

Protective covers for most products are also available as accessories. Covers can be utilized to protect the lock cylinders when located outdoors or in a demanding environment.

Type FF Isolation Interlock



Part of the
Sentric Group

TECHNICAL DATA

Type FF	SD Series
Interlock Housing	Brass
Cylinder Housing	Brass
Plug/Inner Turn Shaft	Brass
Key Material	Nickel-Silver
Key Style	7-Pin Tumbler
Lock Bolt	Stainless Steel
Type of Mounting	"Surface mounted using suitable fasteners. Refer to drawing for details."
Temperature Ratings	-65F to +250F
Weight	.75 pounds

* Weight based on product with 1 cylinder, 0" bolt length, no key, accessories, or mounting hardware

APPLICATION

The Type FF interlocks are used as part of safety systems suitable for the control of electrical switchgear.

The interlock application scheme 1 from the KIRK scheme book is to prevent the opening of switch A when breaker B is closed.

Initial system status: Power is on and Switch A and Breaker B are in the closed position. Key A-1 is held in Breaker B Type FF interlock.

To begin maintenance of switchgear system, open Breaker B and turn key A-1 in L-O (locked open) Type FF bolt interlock on Breaker B to lock open. Key A-1 is now free. Insert key A-1 into L-C (locked closed) Type FF bolt interlock on Switch A and turn and unlock. Open Switch A and key A1- is now trapped.

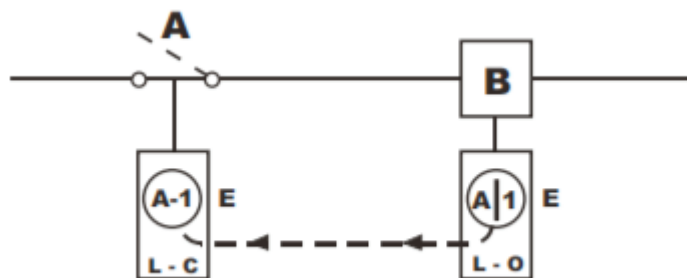

Type FF Isolation Interlock



Part of the
Sentric Group

DRAWING

Dimensions: in inches

SD Series Type FF

